

①

10cm

↑ 6.12



衿

切り込み

ボロシカッ

ボロシカッ

ボロシカッ

ボロシカッ

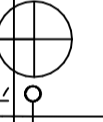
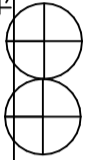
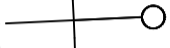

②

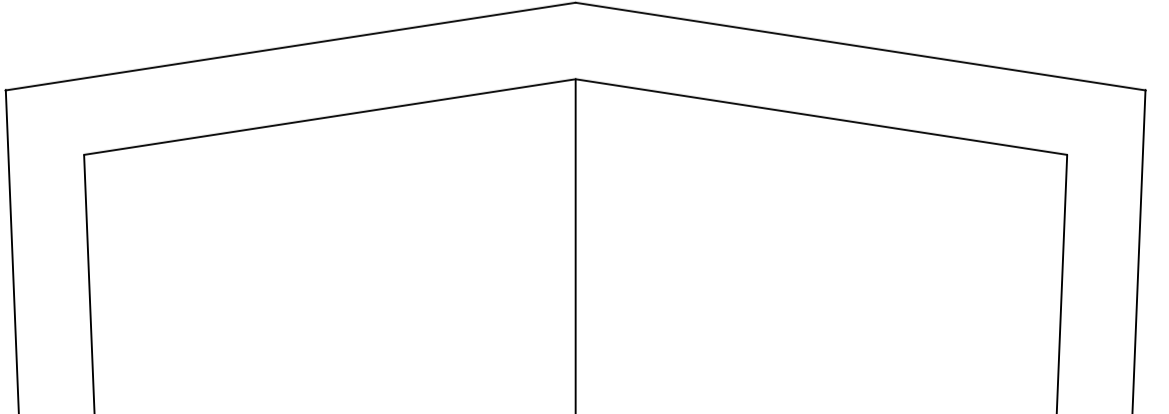
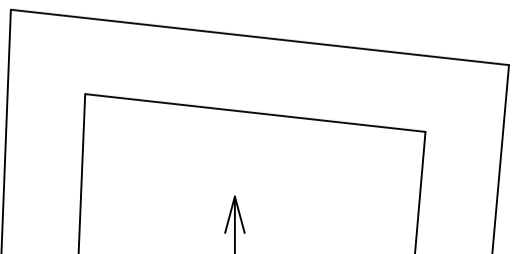

③

【ボズ工房】

KS-12-160 上衿2枚

表芯

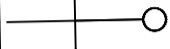

KS-12-160

ポロ衿1枚

【ボズ工房】

表芯

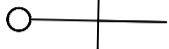
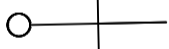
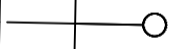

④

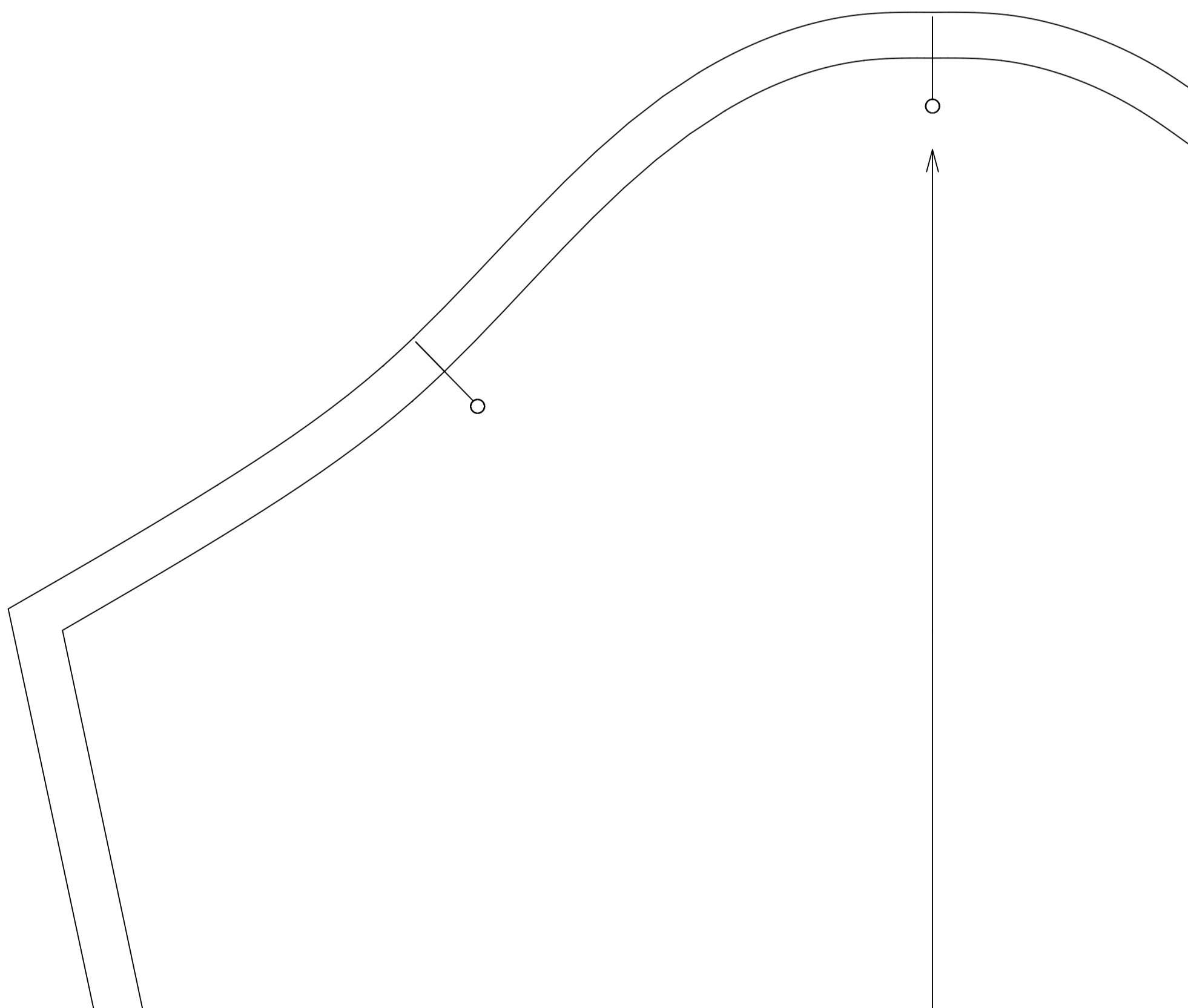
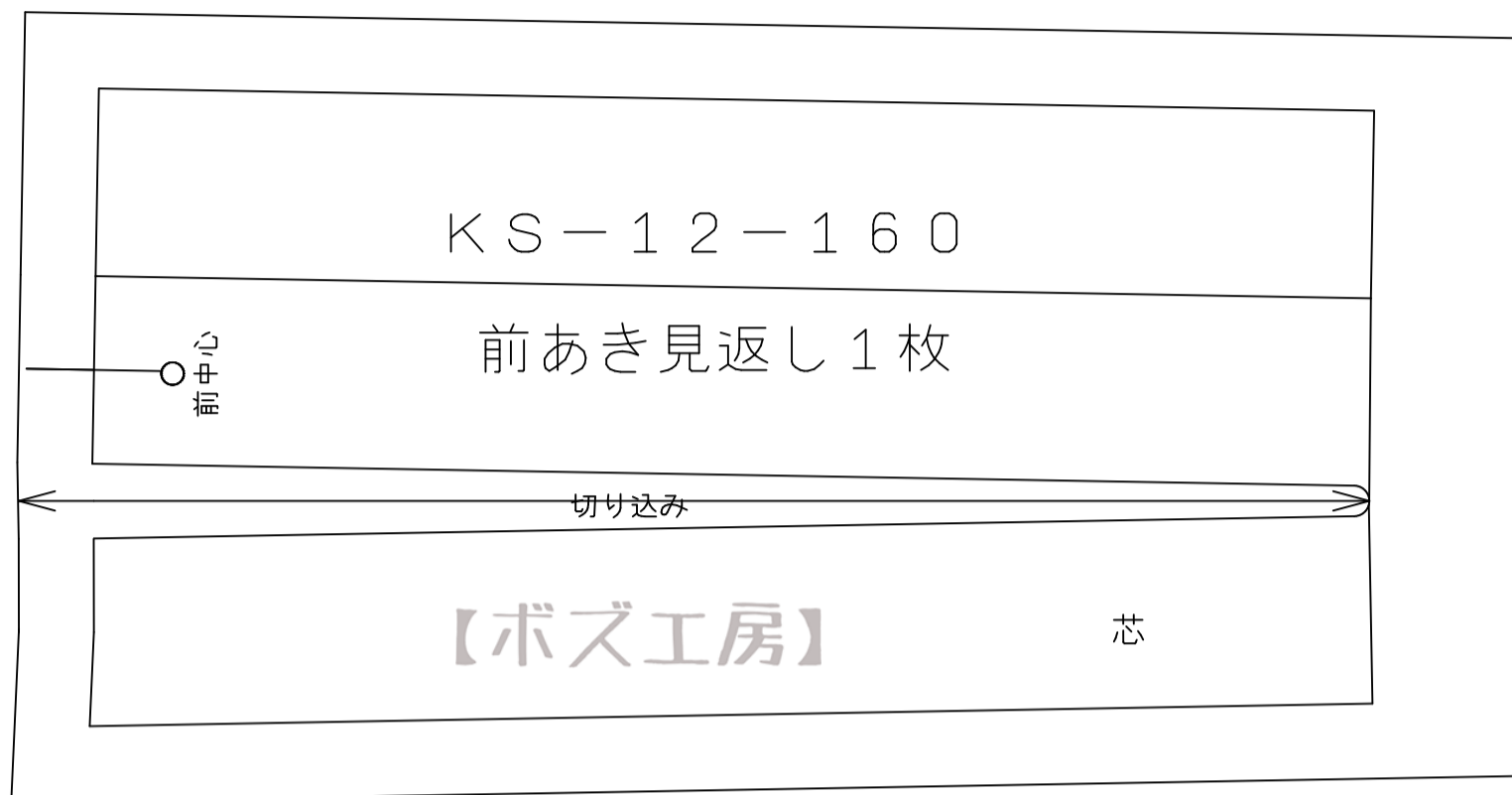

5

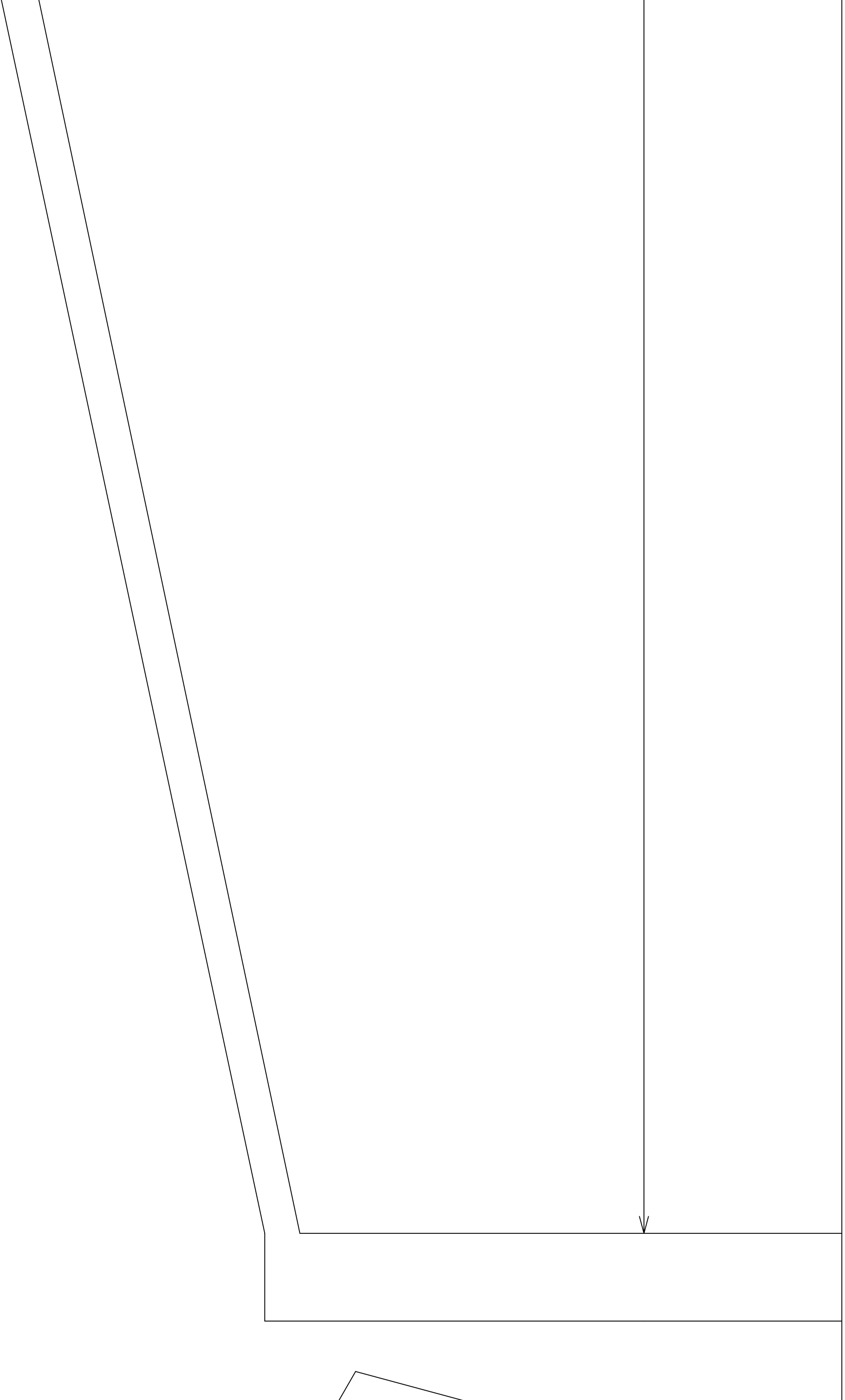

⑥

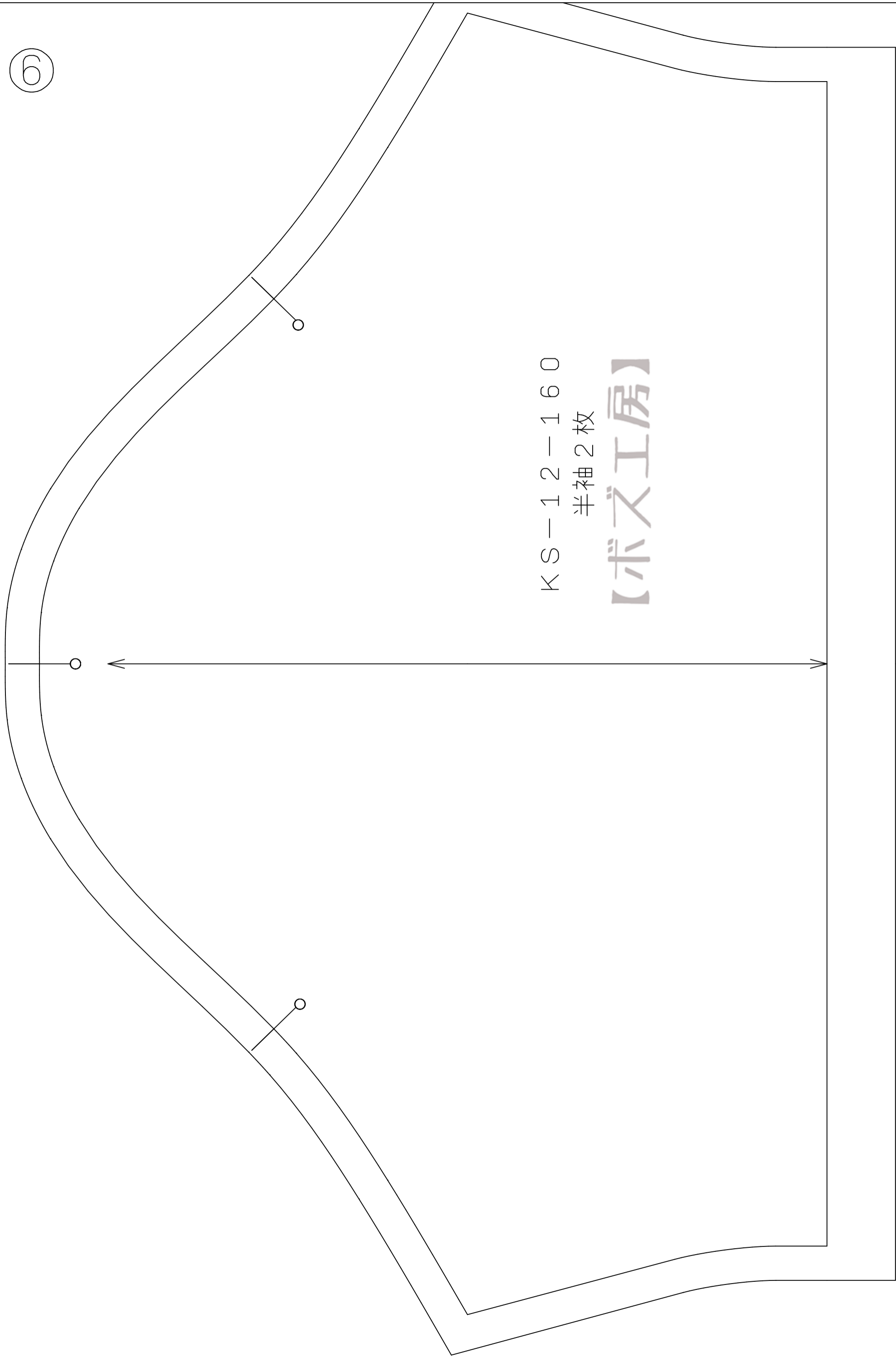

KS-12-160

半袖 2枚

【ボズ工房】

7117

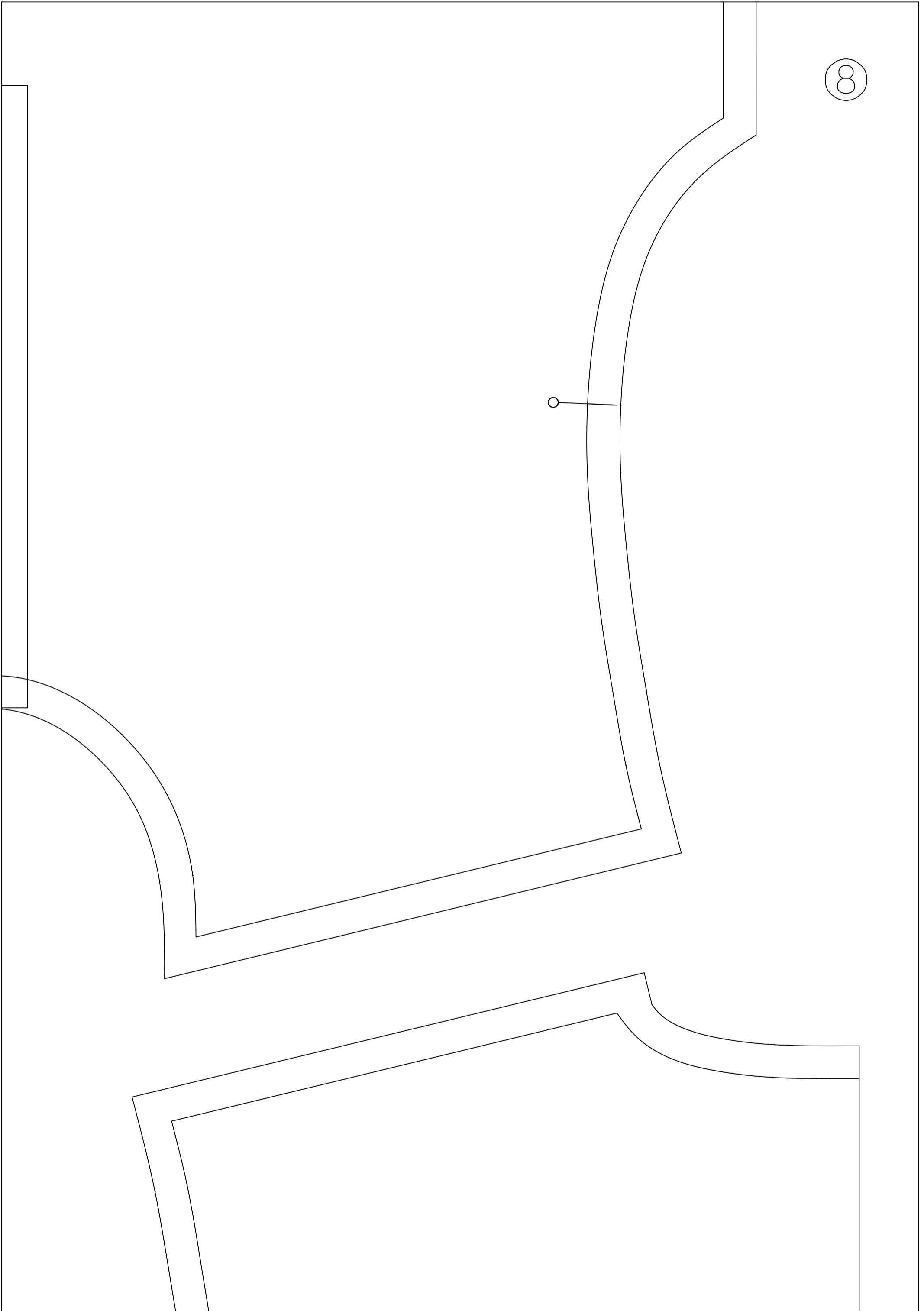



9

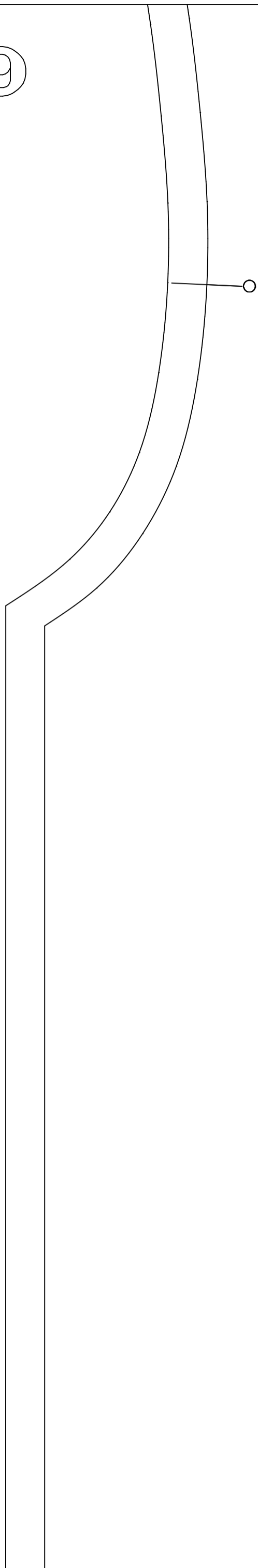

KS-12-160

後身頃1枚

【ボズ工房】

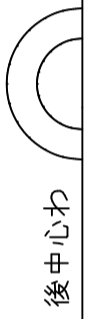

後中心わ

スリット

10

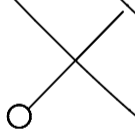

KS-12-160

長袖 2枚

【ボズ工房】

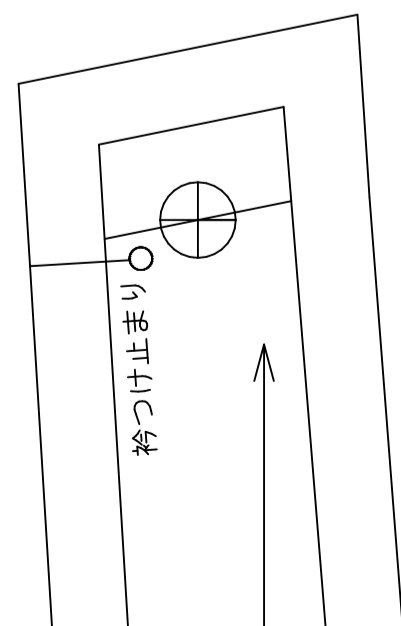

袖つけ止まり

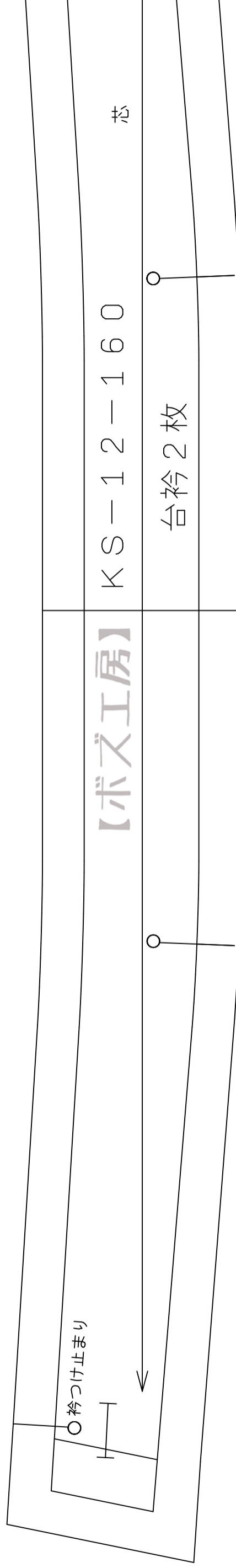
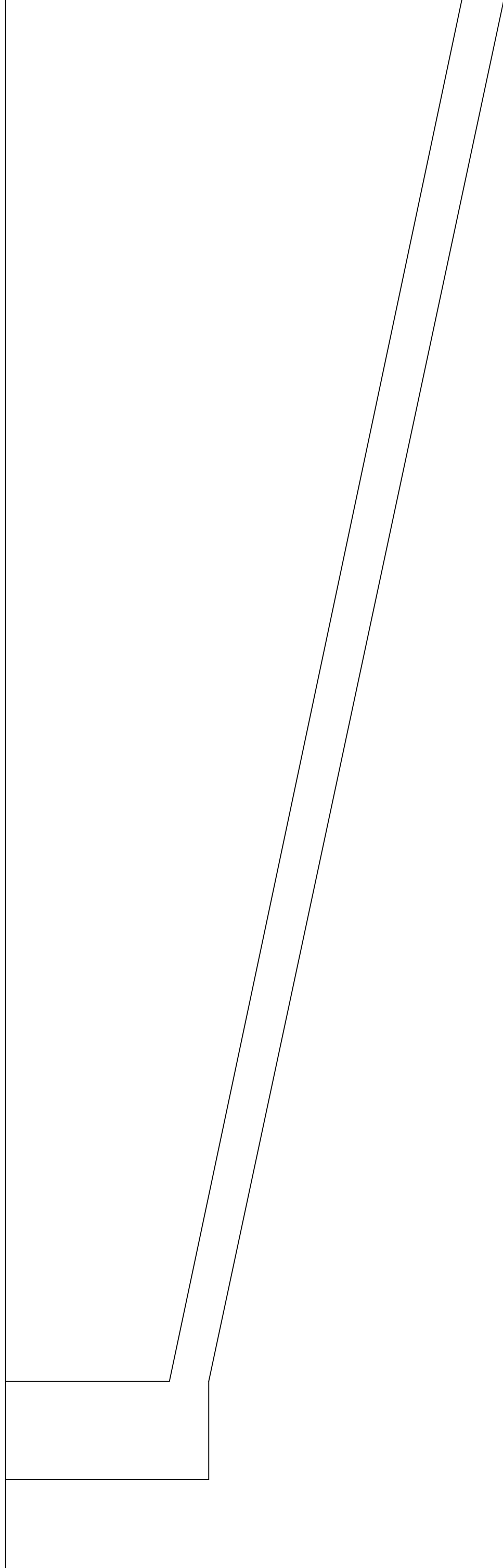

【ボズ工房】

KS-12-160

台衿2枚

芯